



# Approved Components List

## Foundry

For component manufacturing  
of the Volkswagen Group  
“Trade-specific part”

Version date: 01. January 2022  
Version: 2.4

## Change history

Version	Date:	Type of change
1.8	01.01.2016	Editorial updates (Version 1.8) New release list for foundry only added.
1.9	01.01.2017	Editorial updates (Version 1.9)
2.0	01.01.2018	Editorial updates (Version 2.0)
2.1	01.01.2019	Editorial updates (Version 2.1) Adapt template to cover page and structure of corporate template component. Changed: Contacts updated
2.2	01.01.2020	Editorial updates (Version 2.2) Changed: Contacts updated
2.3	01.01.2021	Editorial updates (Version 2.3) Changed: Phone number contact person Andreas Frank. Changed: Section "2.3 3D models" added. Changed: Hyperlinks updated.
2.4	01.01.2022	Editorial updates (Version 2.4) File size and nomenclature to file name adjusted under notes on this document template Changed: Email address contact updated. Changed: Product photos updated. Changed: Fax number removed.

### Note:

This document completes the release list for operating materials for mechanics for the component manufacturing of the Volkswagen Group "Technology-specific part". For this document, we reserve the right of ownership and copyright.

The VOLKSWAGEN AG particularly reserves all rights for a technical use for the provided information in these specifications, including the application and issuing of industrial property rights.

Changes to content are highlighted in **grey**.

## Table of contents

Change history .....	2
1. Contacts: .....	4
2. Notes: .....	5
2.1 Purpose.....	5
2.2 General information.....	5
2.3 3D models .....	5
3. Overview:.....	6
3.1 Grease pumps .....	6
3.1.1 GMV-A.....	6
3.1.2 GMV-B.....	6
3.1.3 GMA-C.B.....	7
3.1.4 GMG-B.....	7
3.1.5 GMF-B .....	7
3.2 Progressive distributors .....	8
3.2.1 VPA – base-plate mounted .....	8
3.2.2 VPB – unit-block system.....	8
3.2.3 VPI – element-based system .....	8
3.3 Flow regulators and delimiters .....	9
3.4 Dual-line distributors .....	9
3.4.1 VZE and VZF, unit-block system .....	9
3.4.2 VZB, element-based system .....	9
3.5 Flow controllers .....	10
3.5.1 Progressive flow control.....	10
3.5.2 Gear-based flow control.....	10
3.6 Equipment.....	10
3.6.1 Hoses.....	10
3.7 Hydraulic filters .....	10
3.7.1 Line filters .....	10

## 1. Contacts:

Eugen WOERNER GmbH & Co. KG  
 Hafenstraße 2  
 D - 97877 Wertheim  
 Phone: +49 (0) 9342 803-0  
 E-Mail: [info@woerner.de](mailto:info@woerner.de)

	Responsible	Contact data
Andreas Frank Key Account Manager Volkswagen	Support of locations worldwide	Phone: +49 (0) 9342 803-330 Mobile: +49 (0) 176 22 87 69 53 E-Mail: <a href="mailto:andreas.frank@woerner.de">andreas.frank@woerner.de</a>
<b>Field service Germany</b>	<b>Responsible</b>	<b>Contact data</b>
Georg Remm Sales Area Manager North	Support of locations: Braunschweig, Chemnitz, Dresden, Emden, Hannover, Kassel, Osnabrück, Salzgitter, Wolfsburg, Zwickau	Leipziger Straße 16 D – 30982 Pattensen Phone: +49 (0) 176 22 87 69 54 E-Mail: <a href="mailto:georg.remm@woerner.de">georg.remm@woerner.de</a>
<b>Sales office service Germany</b>	<b>Responsible</b>	<b>Contact data</b>
Cornelia Nenner Sales office service		Phone: +49 (0) 9342 803-312 E-Mail: <a href="mailto:cornelia.nenner@woerner.de">cornelia.nenner@woerner.de</a>
Sandra Beck Sales office service		Phone: +49 (0) 9342 803-310 E-Mail: <a href="mailto:sandra.beck@woerner.de">sandra.beck@woerner.de</a>

## **2. Notes:**

### **2.1 Purpose**

The basis for the following approval list is the specification sheet Mechanics for the Component Production of the Volkswagen Group in the respective current issue. The respective requirements and restrictions must be observed.

### **2.2 General information**

The department for offers and projects of WOERNER GmbH & Co. KG is responsible for creation and updating of the approval list.

The contents as well as the layout of the release list were specified in cooperation with Volkswagen AG.



### **2.3 3D models**

All products marked with "3D models" in the "Documentation" field are available for download via a link from the homepage of Eugen WOERNER GmbH & Co. KG. All products without this marking, are available as a 3D model in STEP format, but must be obtained from our contact persons (see chapter 1).



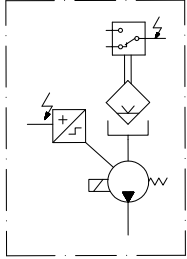

### 3. Overview:

#### 3.1 Grease pumps

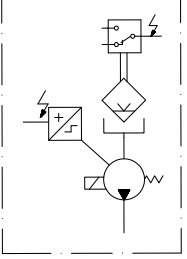

##### 3.1.1 GMV-A

Description	Symbol	Illustration	Documentation
<p>GMV-A piston pump Solenoid or pneumatic cylinder Different connections for reservoirs and cartridges System Lube Shuttle (400 g) or Cartridge System Reiner (500 g) Level monitoring 1 outlet 25 ... 30 mm<sup>3</sup></p>			<p> <a href="#">datasheet</a></p>

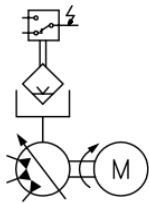

##### 3.1.2 GMV-B

Description	Symbol	Illustration	Documentation
<p>GMV-B piston pump Solenoid or Pneumatic drive Reservoir for grease cartridges acc. to DIN 1283 (400 g) Level monitoring 1 outlet 25 ... 30 mm<sup>3</sup></p>			<p> <a href="#">datasheet</a>  <a href="#">3D models</a></p>

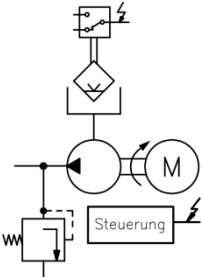

### 3.1.3 GMA-C.B

Description	Symbol	Illustration	Documentation
<p>GMA-C pump unit</p> <p>Multi-line piston pump</p> <p>Speed 1, 4, 5 or 25 rpm</p> <p>Polyester container 5 or 10 litres with min. / max. level control through grease follower piston or float switch</p> <p>1 to 4 pump elements</p> <p>0.08 to 0.22 cm<sup>3</sup>/stroke each</p>			<p><a href="#">datasheet</a></p> <p><a href="#">3D models</a></p>

### 3.1.4 GMG-B

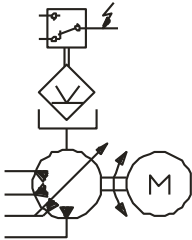

Description	Symbol	Illustration	Documentation
<p>GMG-B pump unit</p> <p>Multi-line piston pump</p> <p>Speed 30 rpm</p> <p>Polyamide container 4 litres with minimum level monitoring</p> <p>1 or 2 pump elements</p> <p>0.04 to 0.16 cm<sup>3</sup>/stroke each</p>			<p><a href="#">datasheet</a></p> <p><a href="#">3D models</a></p>

### 3.1.5 GMF-B

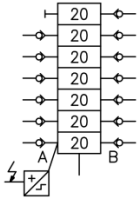

Description	Symbol	Illustration	Documentation
<p>GMF-B pump unit</p> <p>Multi-line piston pump</p> <p>Number of strokes 1 to 25 1/min.</p> <p>Polyester container 5, 10 or 30 litres</p> <p>Steel container 2, 4, 7 or 25 litres with min./max. level control</p> <p>1 to 10 pump elements</p> <p>0.08, 0.15 or 0.22 cm<sup>3</sup>/stroke each</p>			<p><a href="#">datasheet</a></p> <p><a href="#">3D models</a></p>

## 3.2 Progressive distributors

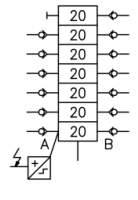

### 3.2.1 VPA – base-plate mounted

Description	Symbol	Illustration	Documentation
<p>Progressive distributor Base-plate mounted Material: Aluminium or bronze 6 to 20 outlets Various operating controls Metering volume 0.09 to 3.7 cm<sup>3</sup></p>			<p><a href="#">datasheet</a> <a href="#">3D models</a></p>

### 3.2.2 VPB – unit-block system



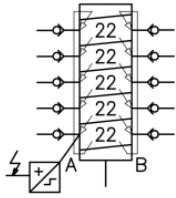

Description	Symbol	Illustration	Documentation
<p>Progressive distributor Unit-block system Material: Aluminium or bronze 6 to 20 outlets Various operating controls Metering volume 0.05 to 0.20 cm<sup>3</sup></p>			<p><a href="#">datasheet</a> <a href="#">3D models</a></p>

### 3.2.3 VPI – element-based system

Description	Symbol	Illustration	Documentation
<p>Progressive distributor Unit-block system Directional control valves and flow control valves to be attached 6 to 20 outlets Various operating controls Metering volume 0.10 to 3.70 cm<sup>3</sup></p>			<p><a href="#">datasheet</a> <a href="#">3D models</a></p>

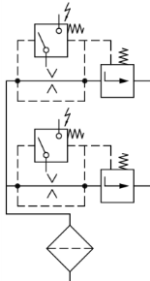





### 3.3 Flow regulators and delimiters

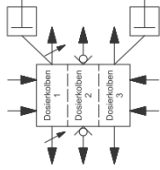

Description	Symbol	Illustration	Documentation
<p>Flow regulator Flow rate from 0.1 to 5 l/min infinitely variable</p> <p>Flow delimiter Flow rate from 0.5 to 16 l/min adjustable with orifices</p>			<p>VUA  <a href="#">datasheet</a></p> <p>VUK  <a href="#">datasheet</a></p> <p>VUL  <a href="#">datasheet</a></p>

### 3.4 Dual-line distributors

#### 3.4.1 VZE and VZF, unit-block system

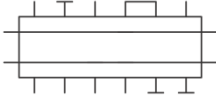
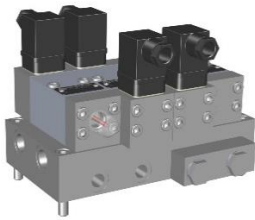

Description	Symbol	Illustration	Documentation
<p>Dual-line distributor Unit-block system material: Steel or stainless steel 2 to 8 outlets Optical or electrical monitoring metering volume up to 3.0 cm<sup>3</sup></p>			<p>VZE  <a href="#">datasheet</a></p> <p>VZF  <a href="#">datasheet</a></p>

#### 3.4.2 VZB, modular design



Description	Symbol	Illustration	Documentation
<p>Dual-line distributor Element-based system Material: Aluminum 2 to 12 outlets Optical or electrical monitoring Metering volume up to 7.0 cm<sup>3</sup></p>			<p> <a href="#">datasheet</a></p>

### 3.5 Flow controllers

#### 3.5.1 Progressive flow control



Description	Symbol	Illustration	Documentation
<p>Progressive flow control for oil and grease max. 700 respectively 70 cm<sup>3</sup>/min One switching pulse per every 0.8 or 1.2 cm<sup>3</sup></p>			 <a href="#">datasheet</a>

#### 3.5.2 Gear-based flow control

Description	Symbol	Illustration	Documentation
<p>Flow control with pair of gearwheels for oil and grease 0 ... 2.5 l/min Operating pressure up to 700 bar</p>			 <a href="#">datasheet</a>



### 3.6 Equipment

#### 3.6.1 Hoses

Description	Symbol	Illustration	Documentation
<p>Hydraulic hose assemblies to be used as lubricating lines for self-installation Nominal width 6 ... 10 mm Pipe fitting: Straight or 90° bent Fittings made from steel for nominal widths 4 and 6 mm, also made from 1.4571</p>			 <a href="#">datasheet</a>

### 3.7 Hydraulic filters

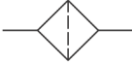
#### 3.7.1 Line filters

Description	Symbol	Illustration	Documentation
<p>Single-flow filter for grease and low- viscosity grease for line assembly up to 350 bar</p>			 <a href="#">datasheet</a>